

Областные соревнования Летние Баренц Игры

30.08.2019 - 31.08.2019 г. Мурманск

Юни 55 kg

5 players



Group A1

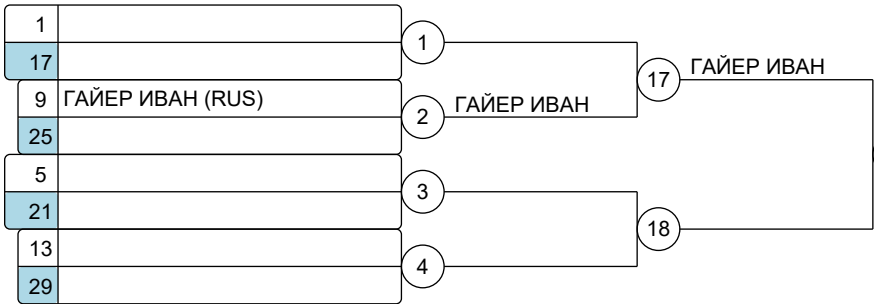

Group A2

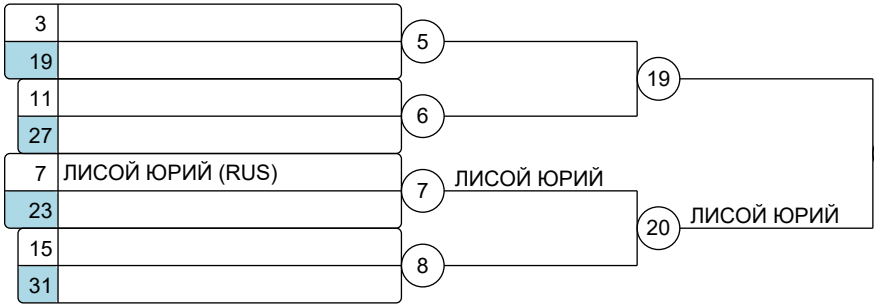

Group B1

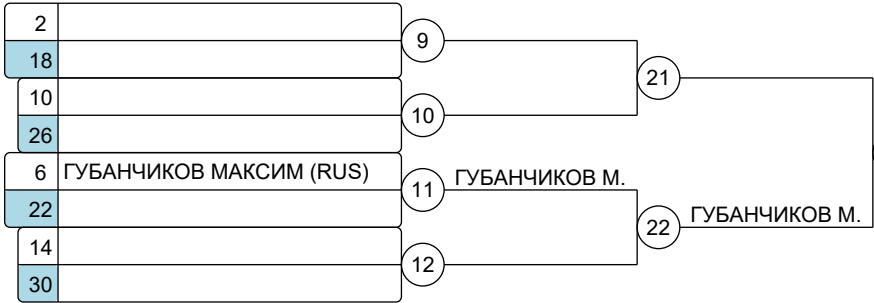

Group B2

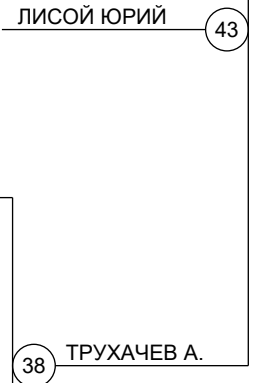
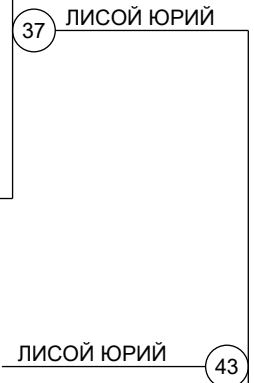
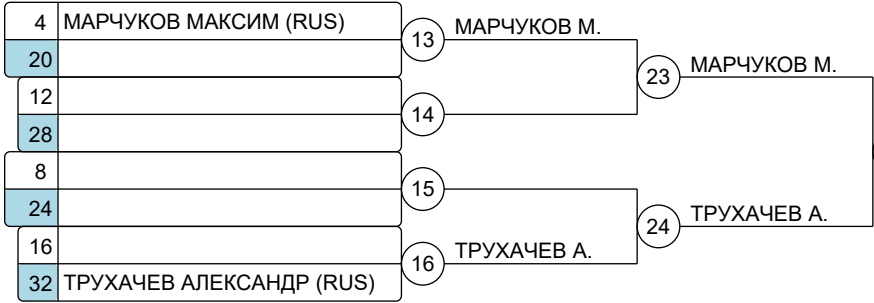

Results

- ЛИСОЙ ЮРИЙ (RUS)
- ТРУХАЧЕВ А. (RUS)
- ГУБАНЧИКОВ МАКСИМ (RUS)
- ГАЙЕР ИВАН (RUS)
- МАРЧУКОВ МАКСИМ (RUS)

Repechage

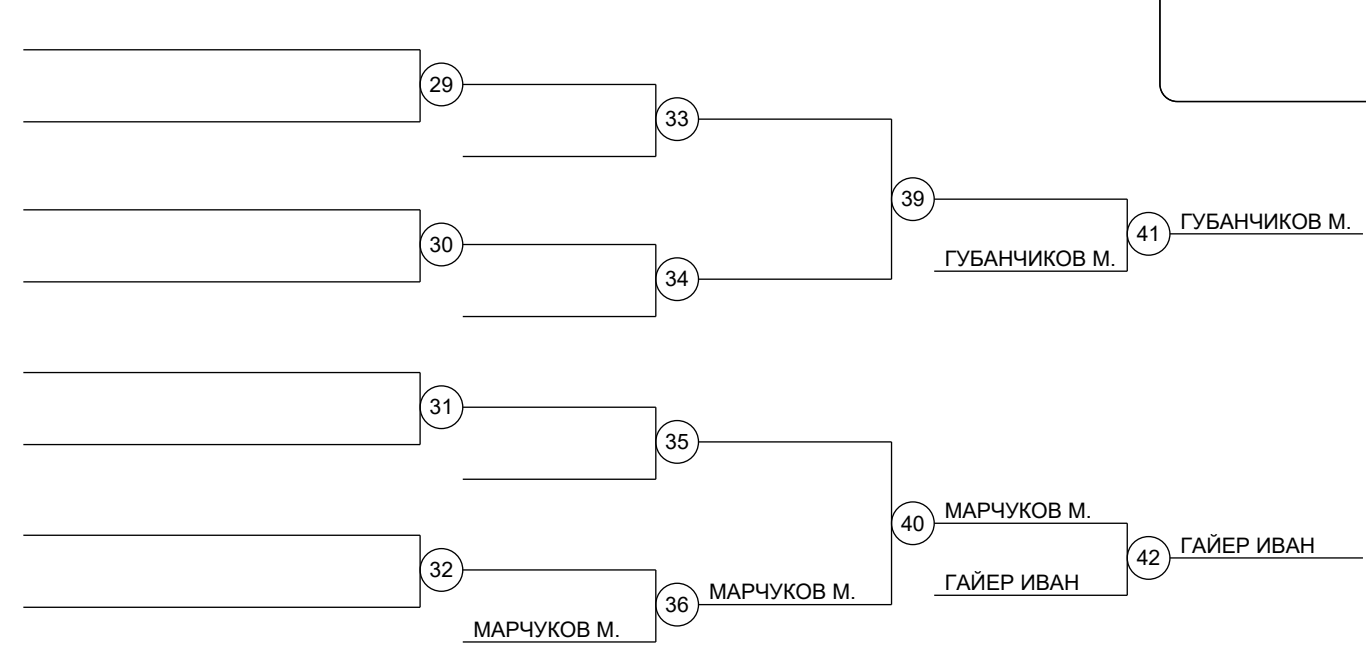

Областные соревнования Летние Баренц Игры

30.08.2019 - 31.08.2019 г. Мурманск

Юни 60 kg

6 players



Group A1

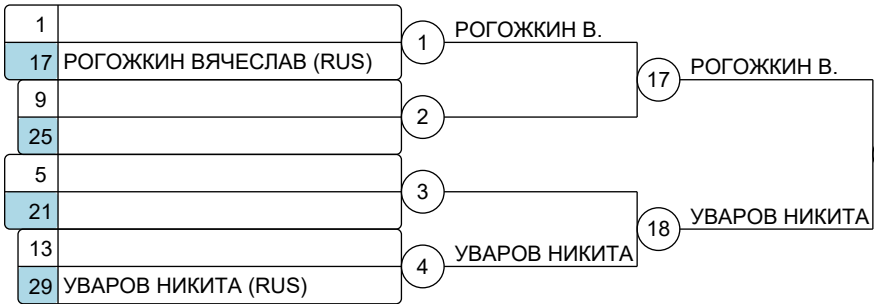

Group A2

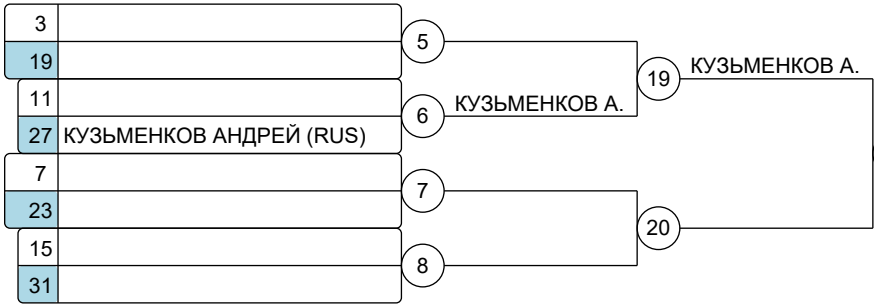

Group B1

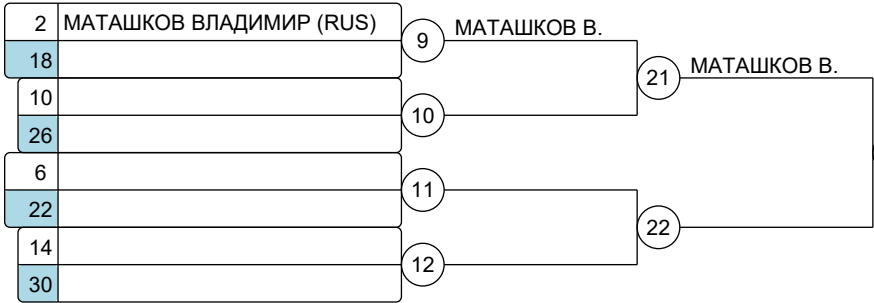

Group B2

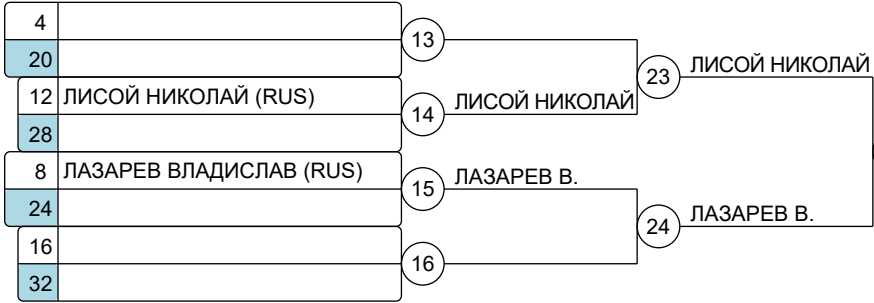

- Results**
1. ЛИСОЙ НИКОЛАЙ (RUS)
 2. КУЗЬМЕНКОВ АНДРЕЙ (RUS)
 3. МАТАШКОВ В. (RUS)
 3. РОГОЖКИН ВЯЧЕСЛАВ (RUS)
 5. УВАРОВ НИКИТА (RUS)
 5. ЛАЗАРЕВ ВЛАДИСЛАВ (RUS)

Repechage

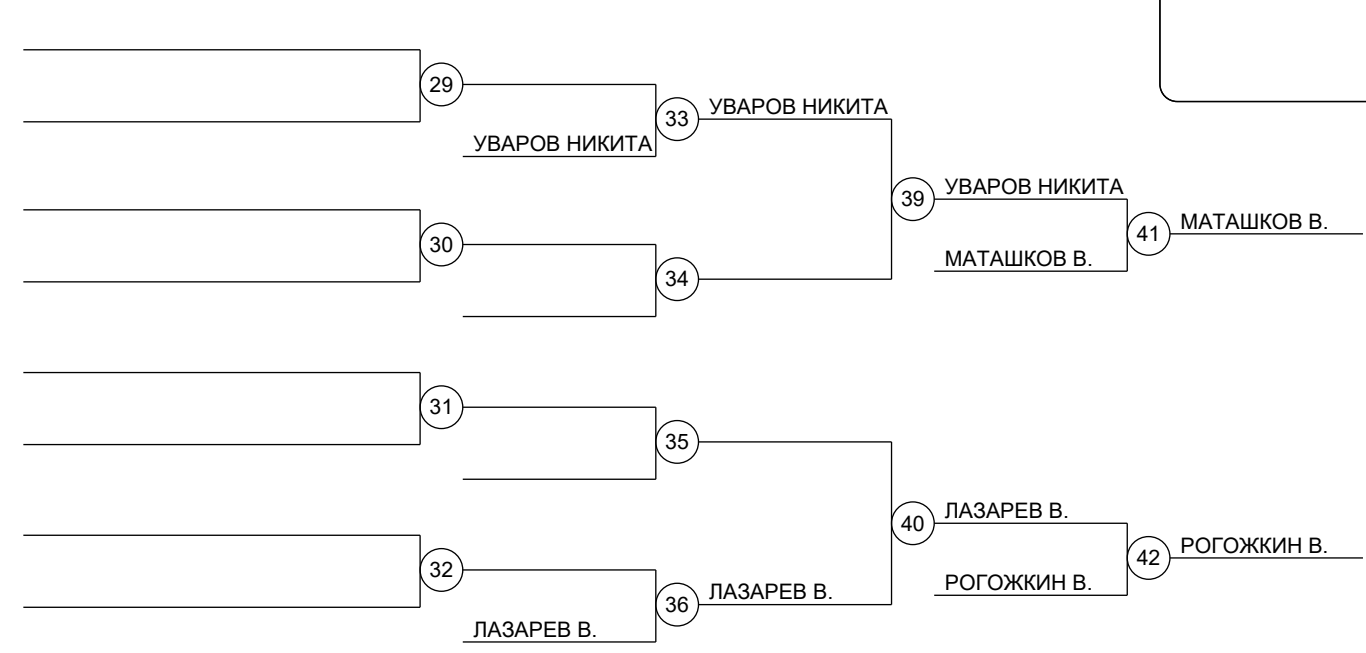

Областные соревнования Летние Баренц Игры

30.08.2019 - 31.08.2019 г. Мурманск

Юни 66 kg

6 players



Group A1

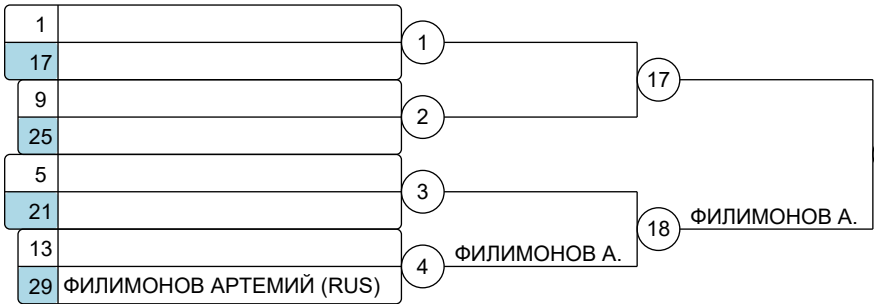

Group A2

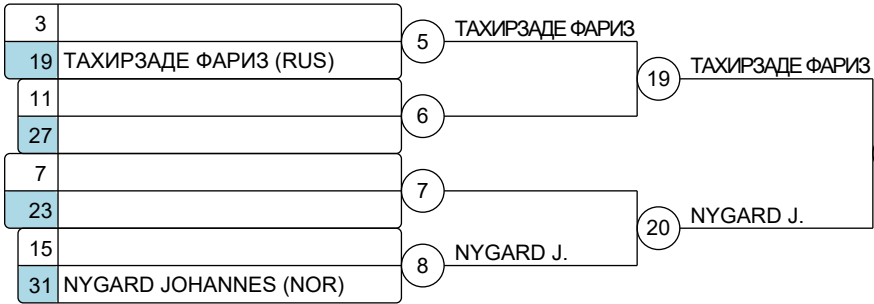

Group B1

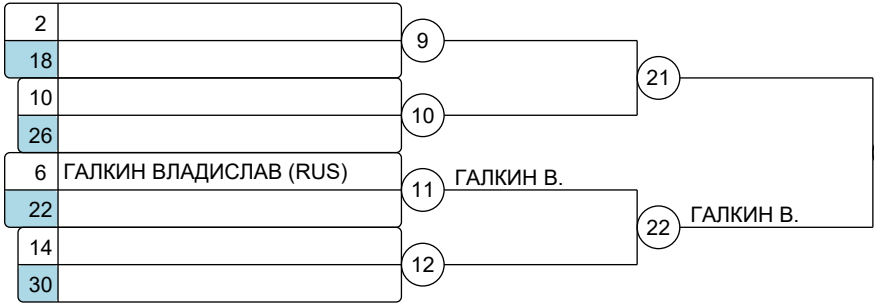

Group B2

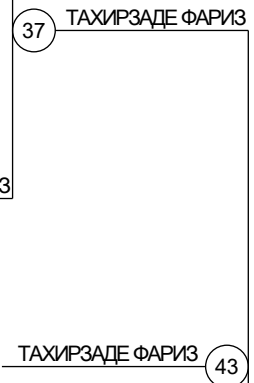
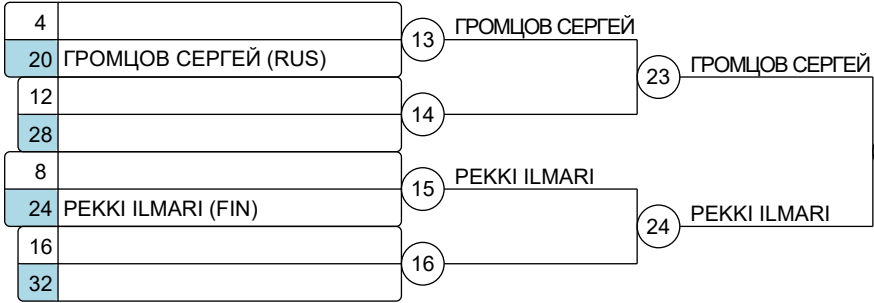

Results

- ТАХИРЗАДЕ ФАРИЗ (RUS)
- РЕККИ ИLMARI (FIN)
- ГАЛКИН ВЛАДИСЛАВ (RUS)
- ФИЛИМОНОВ А. (RUS)
- ГРОМЦОВ СЕРГЕЙ (RUS)
- NYGARD JOHANNES (NOR)

Repechage

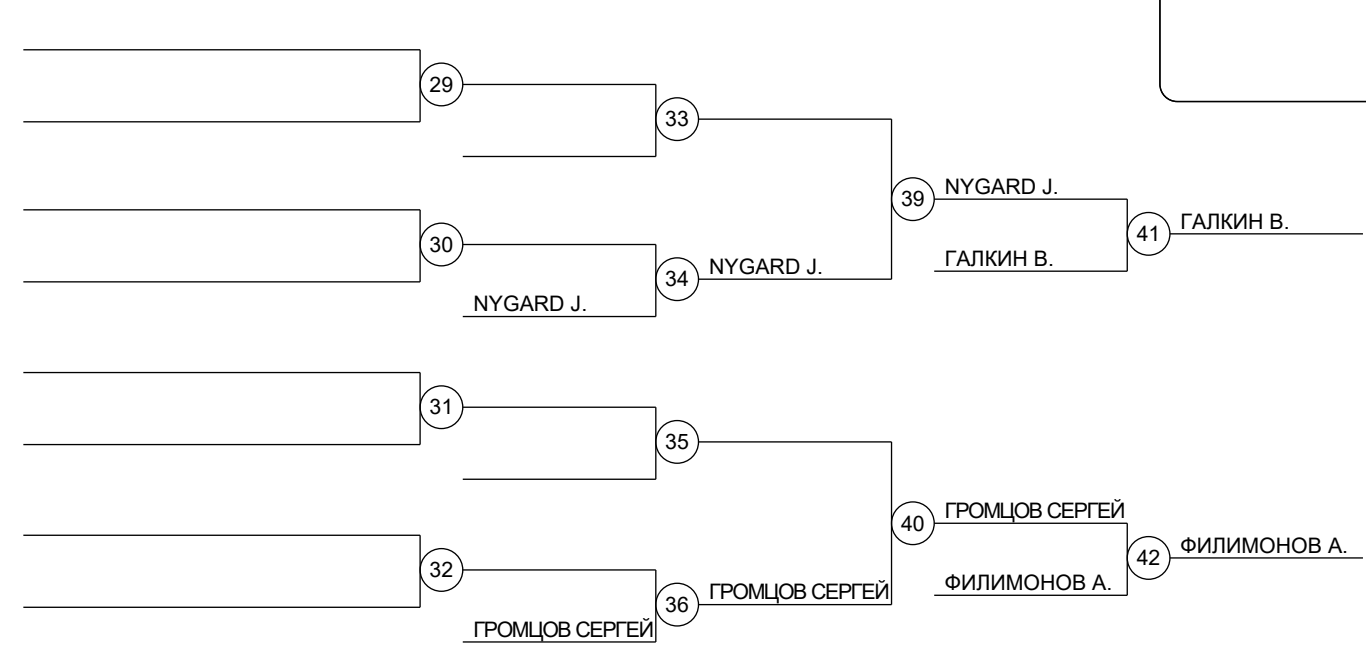

Областные соревнования Летние Баренц Игры

30.08.2019 - 31.08.2019 г. Мурманск

Юни 73 kg

4 players



Group A1

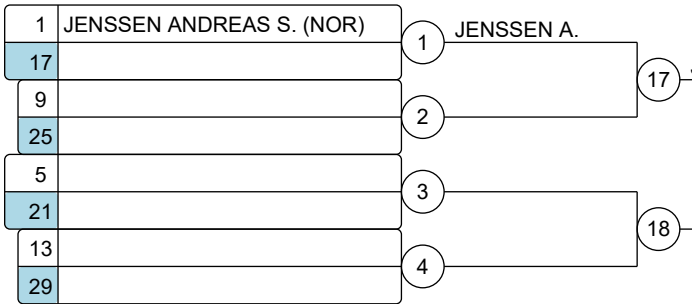

Group A2

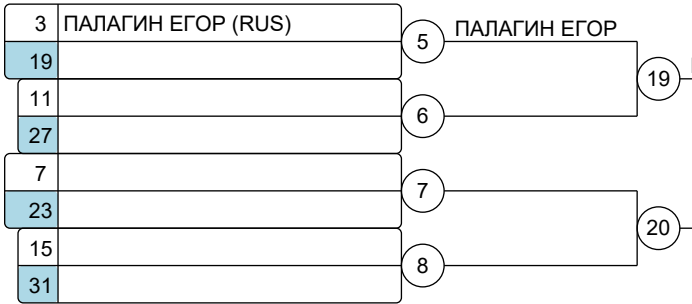

Group B1

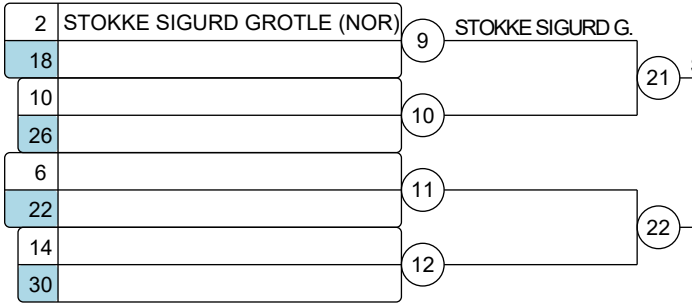

Group B2

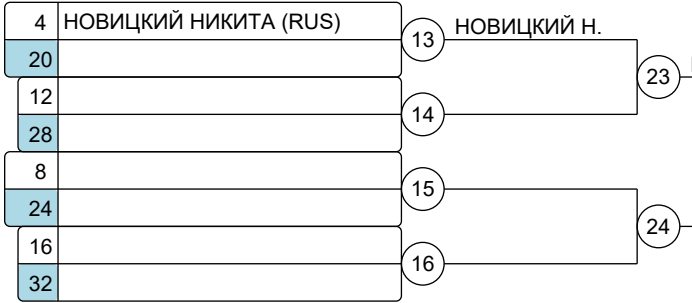

Results

1. STOKKE SIGURD G. (NOR)
2. ПАЛАГИН ЕГОР (RUS)
3. НОВИЦКИЙ НИКИТА (RUS)
3. JENSSEN ANDREAS S. (NOR)

Repechage

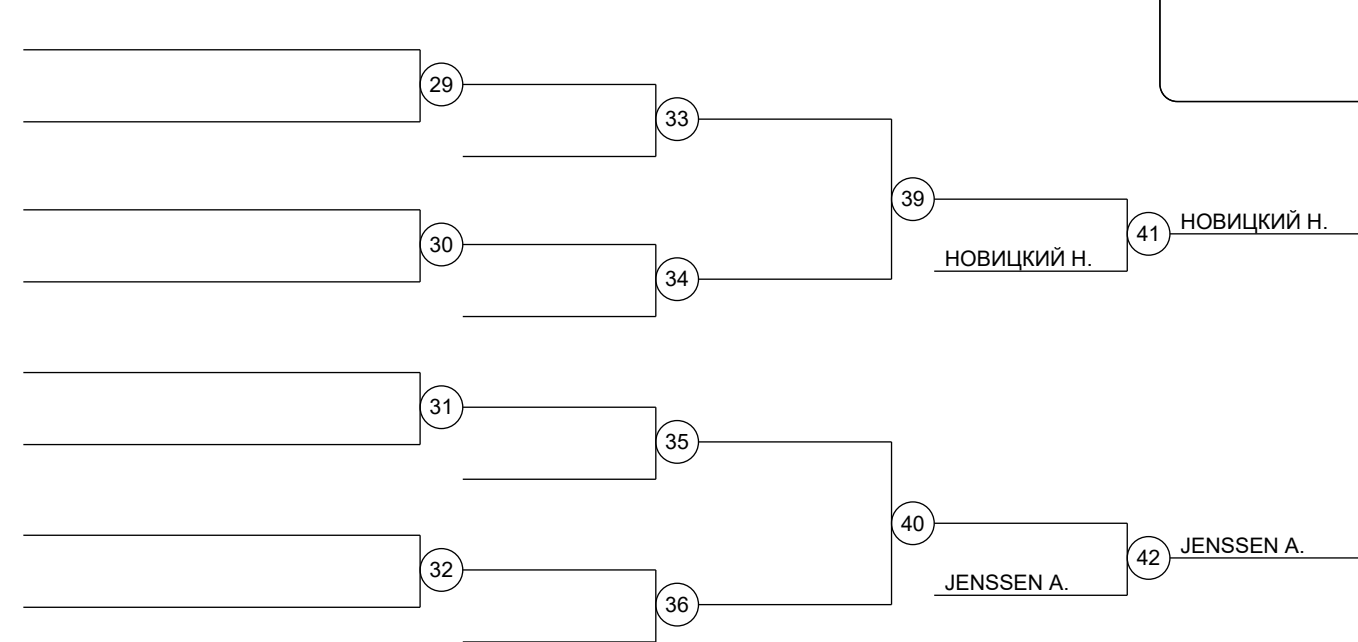

Областные соревнования Летние Баренц Игры

30.08.2019 - 31.08.2019 г. Мурманск

Юни 81 kg



N	Player	Score	Score	Score	Wins	Points	Place
1	FORSBO ELIAS NIKOLAI (NOR)		0	10	1	10	2
2	BERG JONI (FIN)	10		10	2	20	1
3	ОРЛОВ АЛЕКСЕЙ (RUS)	0	0		0	0	3

Pair	Player 1	Player 2	Result
Round 1			
[1 - 2]	FORSBO ELIAS NIKOLAI (NOR)	BERG JONI (FIN)	0 : 10
Round 2			
[1 - 3]	FORSBO ELIAS NIKOLAI (NOR)	ОРЛОВ АЛЕКСЕЙ (RUS)	10 : 0
Round 3			
[3 - 2]	ОРЛОВ АЛЕКСЕЙ (RUS)	BERG JONI (FIN)	0 : 10

Областные соревнования Летние Баренц Игры

30.08.2019 - 31.08.2019 г. Мурманск

Юни 52 kg

4 players



Group A1

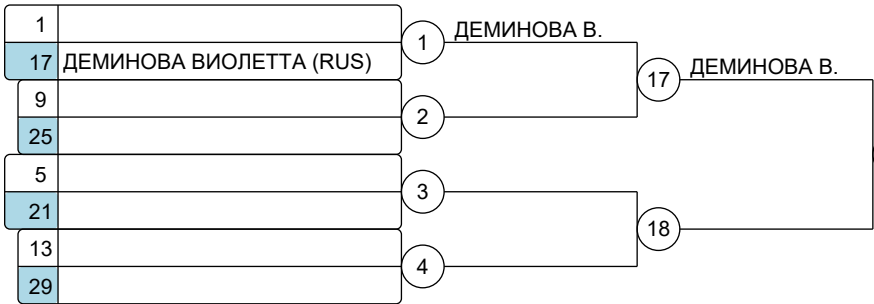

Group A2



Group B1

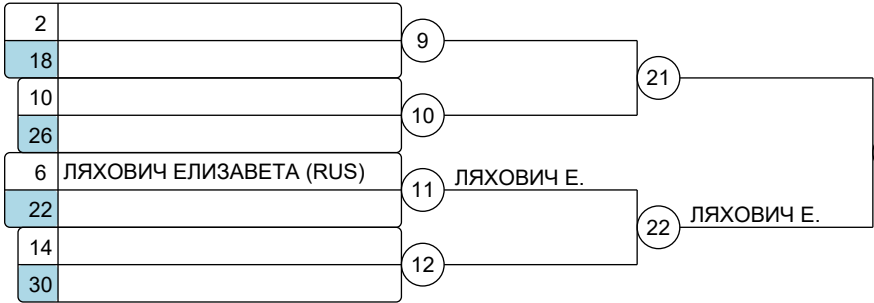

Group B2

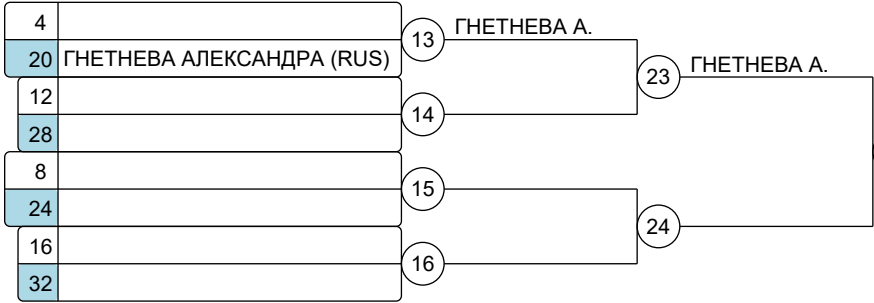

Repechage

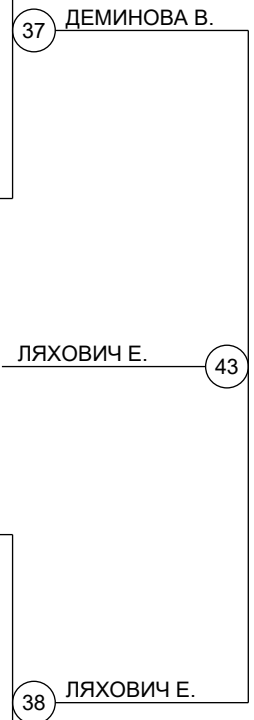
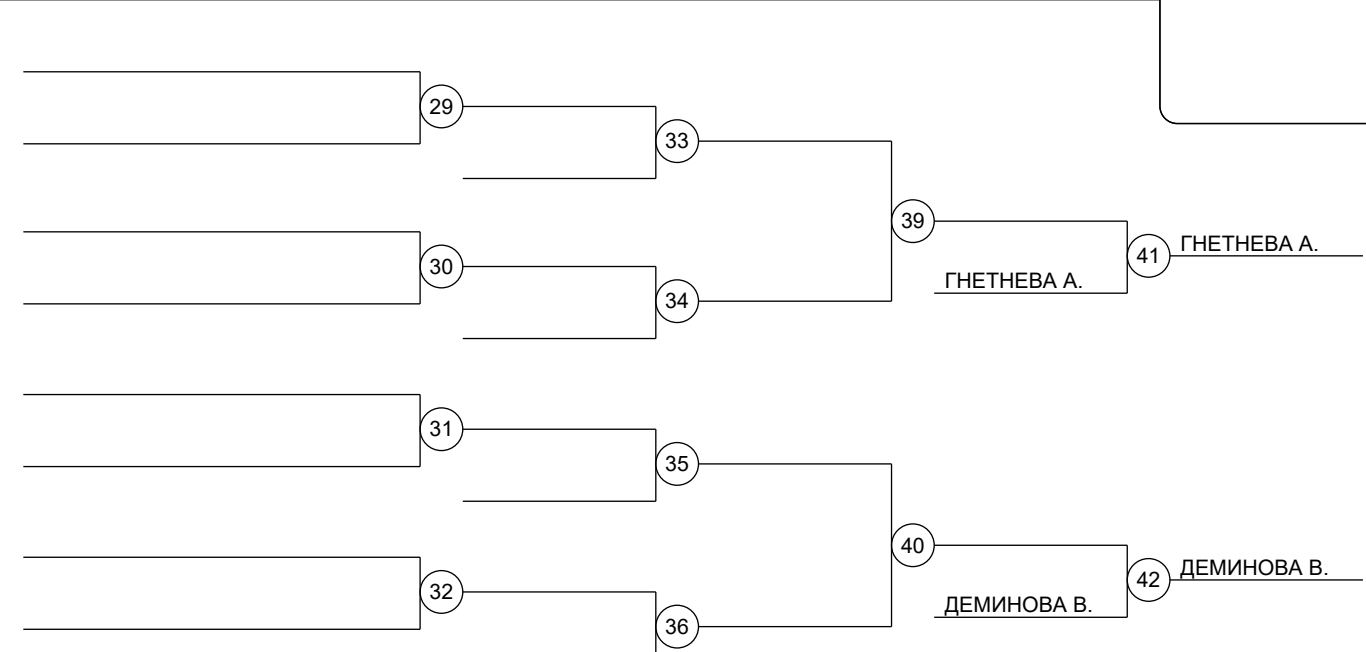

Results

1. ЛЯХОВИЧ ЕЛИЗАВЕТА (RUS)
2. ДЕМИНОВА ВИКТОРИЯ (RUS)
3. ДЕМИНОВА ВИОЛЕТТА (RUS)
3. ГНЕТНЕВА А. (RUS)

Областные соревнования Летние Баренц Игры

30.08.2019 - 31.08.2019 г. Мурманск

Юни 63 kg

4 players



Group A1

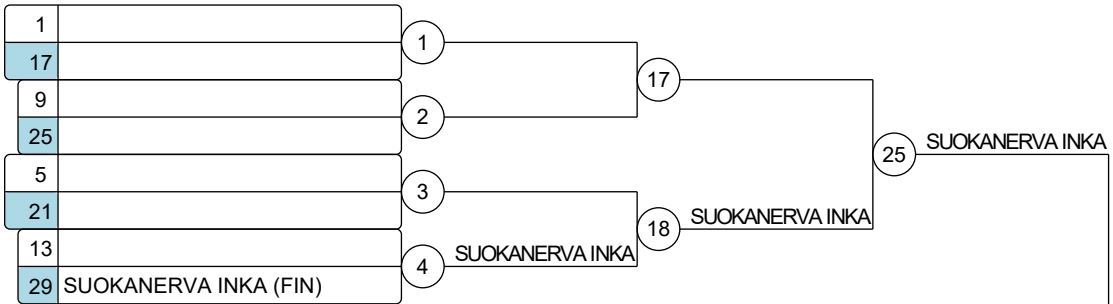

Group A2

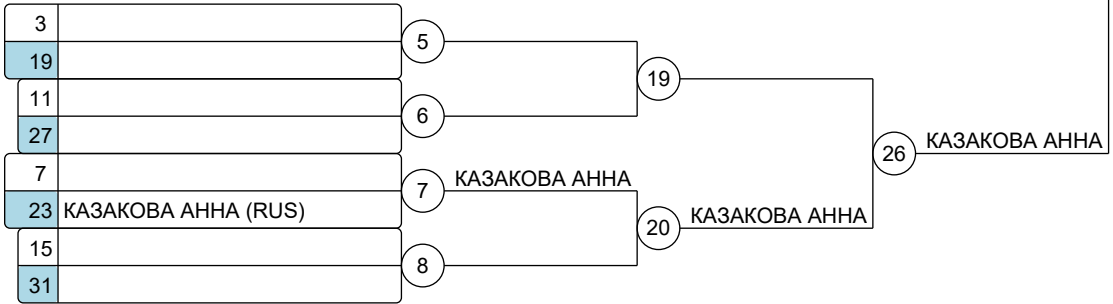

Group B1

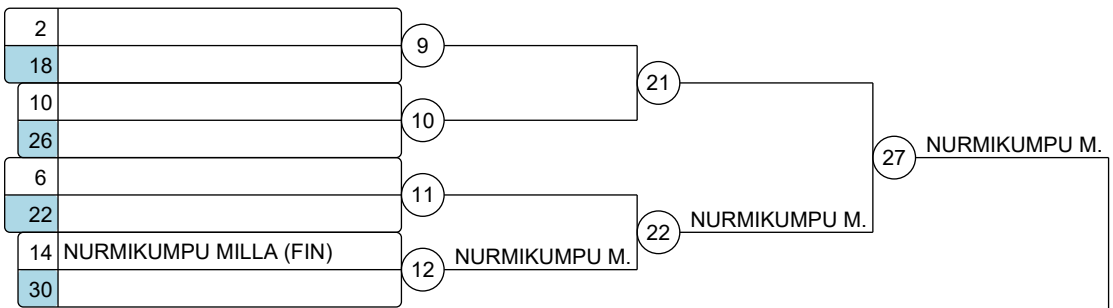

Group B2

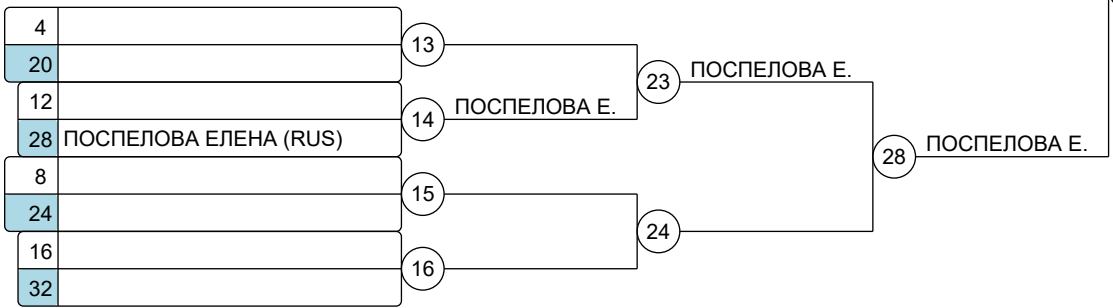

Repechage

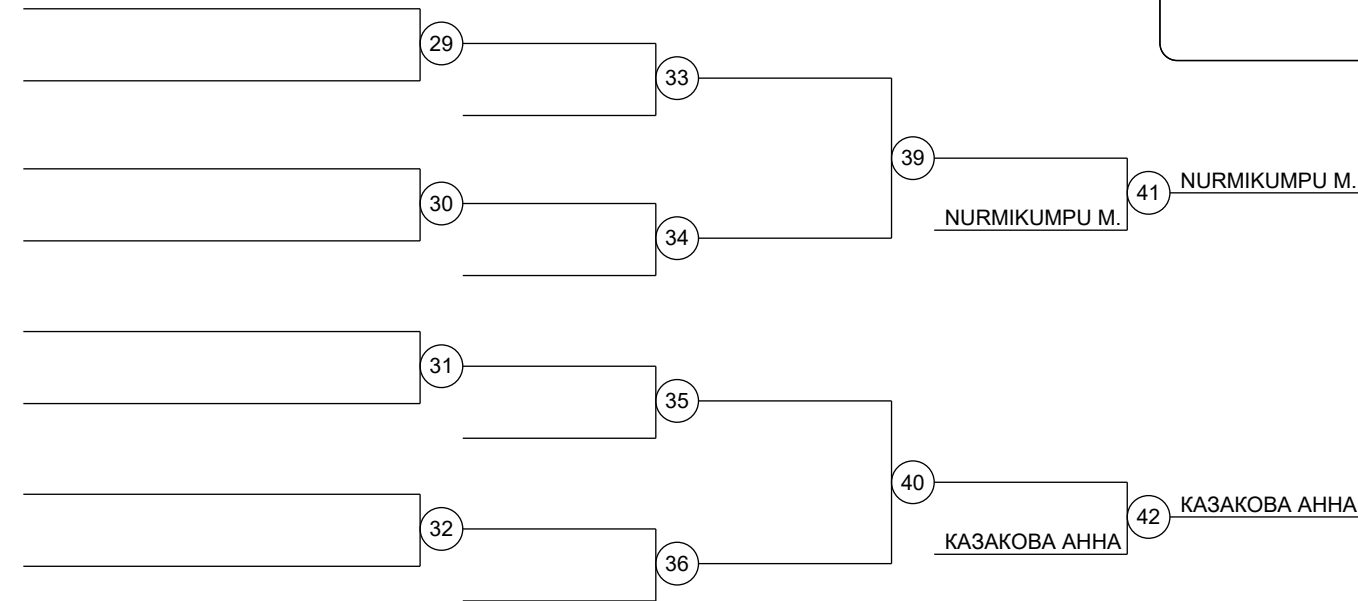

Results

- SUOKANERVA INKA (FIN)
- ПОСПЕЛОВА ЕЛЕНА (RUS)
- КАЗАКОВА АННА (RUS)
- NURMIKUMPU MILLA (FIN)

Областные соревнования Летние Баренц Игры

30.08.2019 - 31.08.2019 г. Мурманск

Юни 70+ kg

5 players



Group A1

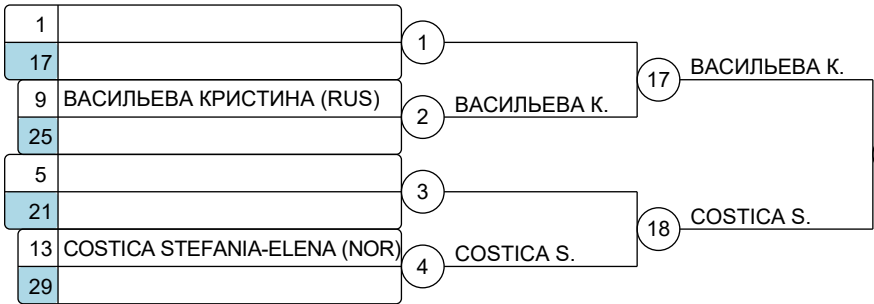

Group A2

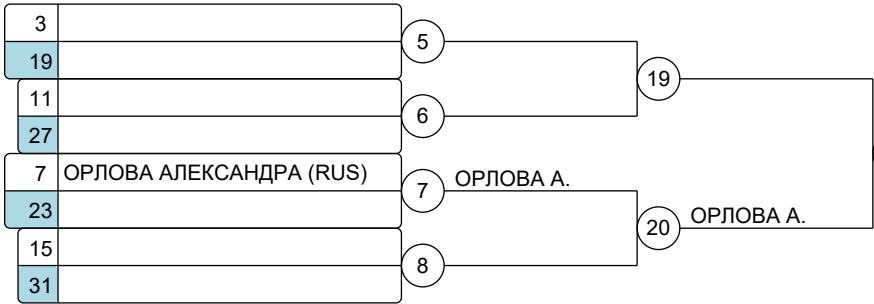

Group B1

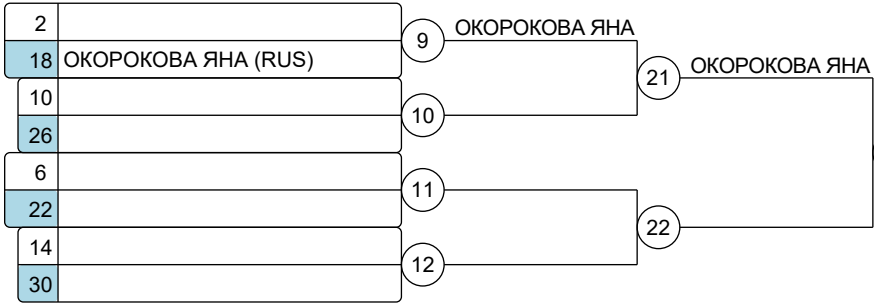

Group B2

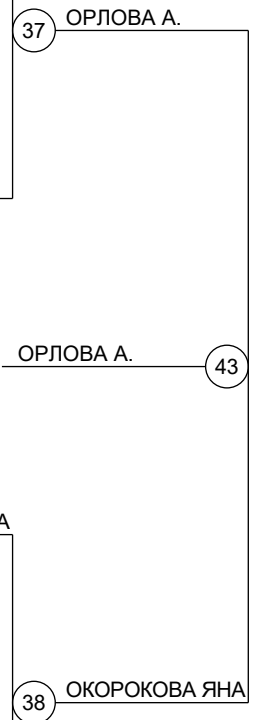
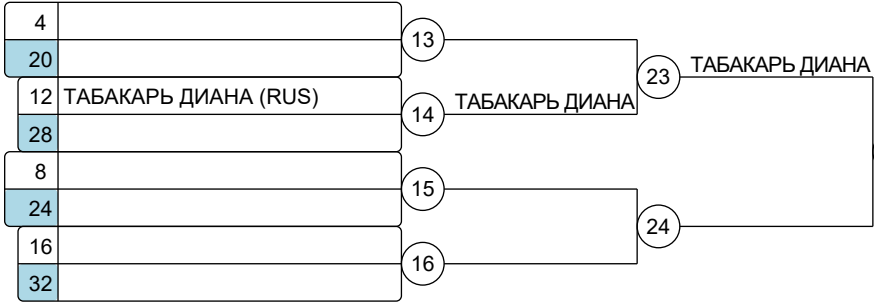

Results

- ОРЛОВА АЛЕКСАНДРА (RUS)
- ОКОРОКОВА ЯНА (RUS)
- ВАСИЛЬЕВА К. (RUS)
- COSTICA S. (NOR)
- ТАБАКАРЬ ДИАНА (RUS)

Repechage

